

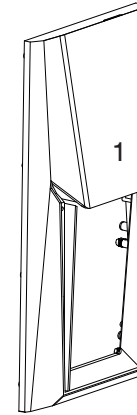

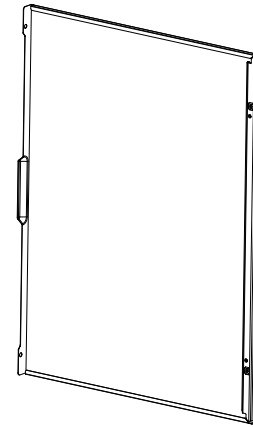

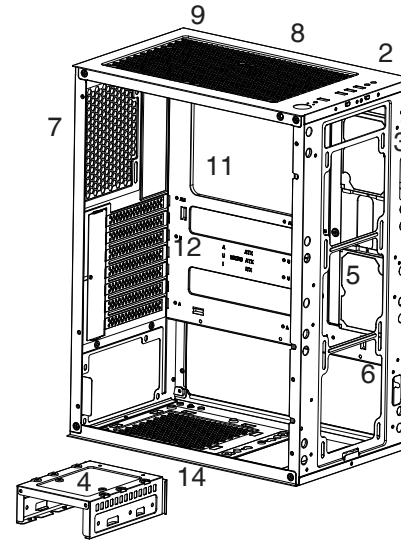

PIONEER

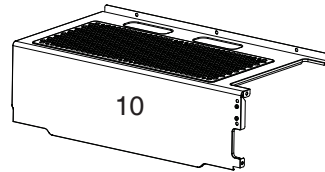
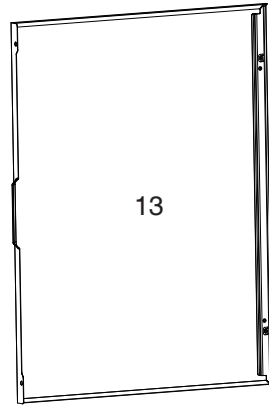

Parts & Accessories

				
x5	x13	x6	x4	x2

1. Stylish Titanium-alike surface with metal mesh front panel
2. 3 USB ports with one headphone and microphone jack on the top
3. Optional 3* 12cm fans on the front structure
4. Drive Frame for 2* 3.5" drive
5. 2* 2.5" SSD
6. Cable management design
7. Optional 1* 12cm fan on the rear
8. Removable magnetic anti-dust cover included
9. Optional 2* 12cm fan on the top
10. Individual cooling zones concept
11. Support the highest CPU cooling kit up to 160mm
12. Support extended graphics cards up to 300mm
13. Tempered glass side panel included
14. Anti-dust net on the bottom for the power supply